

# New Outside Micrometer RATCHET THIMBLE MICROMETER

Bulletin No. 1875



**A new generation, one-handed operation, outside micrometer. Easy, accurate and reliable – even for inexperienced users.**

**Mitutoyo**

# Ratchet Thimble Micrometer

# One-handed

## New, smoother action ratchet thimble mechanism



- Ratchet function works both from the thimble and the speeder, allowing easy one-handed operation.

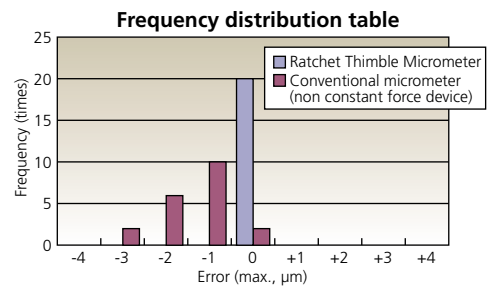

- Greater accuracy even with one-handed operation: test results show inexperienced users measure significantly more accurately with the new Ratchet Thimble Micrometer.

- Speeder is always available for quick rotation of spindle.
- Operate confidently: clearly audible ratchet mechanism provides reassurance that measurement is being performed at a constant, pre-set force.

- New, patented\* constant force ratchet device.

\* Patented: USA, China, Germany, UK, France  
 Patent pending: Japan

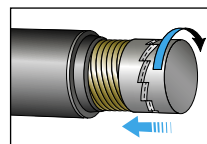
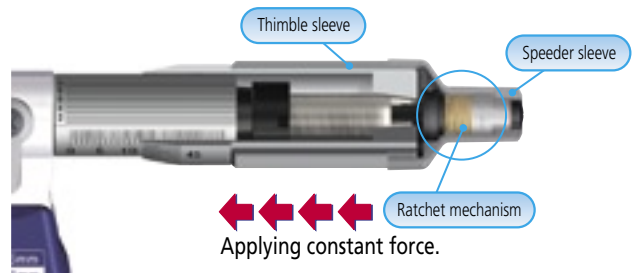

Rotating the thimble/speeder sleeve when the workpiece is between the anvil and spindle causes the ratchet mechanism to operate and apply a constant measuring force to the spindle.

# Operation



Set No. 102-9085

Includes 102-717 and 102-718. Also includes two each of the red, yellow and blue Color Speeder Sleeves.



1"-2"/25-50mm (.001"/0.01mm)

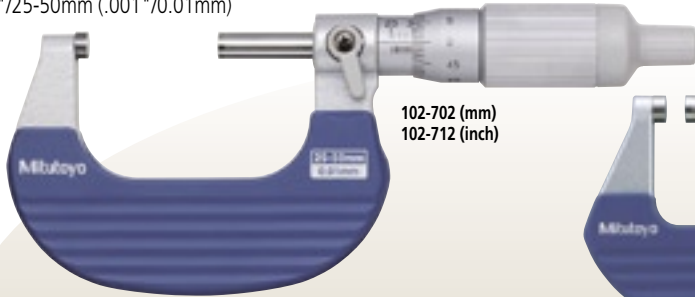

102-702 (mm)  
102-712 (inch)

0"-1"/0-25mm (.001"/0.01mm)

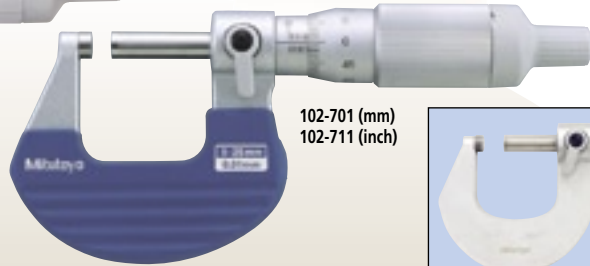

102-701 (mm)  
102-711 (inch)

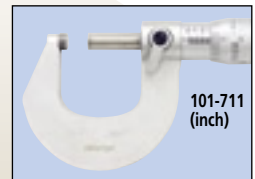

1"-2"/25-50mm (.0001"/0.001mm)

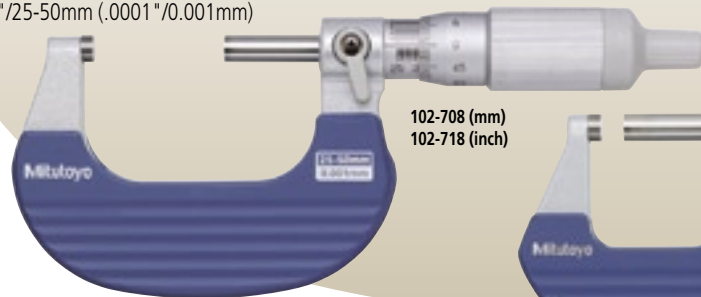

102-708 (mm)  
102-718 (inch)

0"-1"/0-25mm (.0001"/0.001mm)

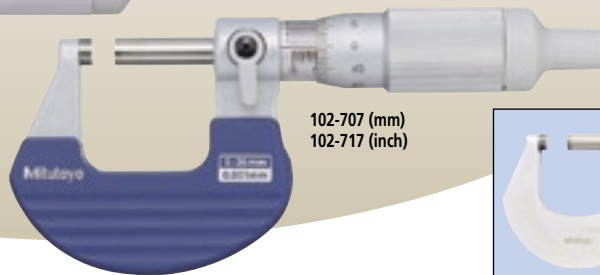

102-707 (mm)  
102-717 (inch)

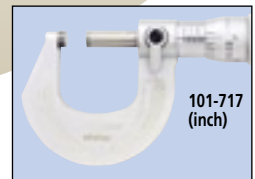

## Specifications

Order No.	102-701	102-707	102-711	102-717	101-711	101-717	102-702	102-708	102-712	102-718
Measuring range	0-25mm		0-1"				25-50mm		1-2"	
Graduation	0.01mm	0.001mm	.001"	.0001"	.001"	.0001"	0.01mm	0.001mm	.001"	.0001"
Instrument error 68°F (20°C)	±2μm		±.0001"				±2μm		±.0001"	
Flatness of measuring faces	0.6μm									
Parallelism of measuring faces	2μm									
Mass	.40 lbs. (180g)						.60 lbs. (270g)			
Measuring force	5N-10N									

## Color speeder sleeve (optional)



Black	04GAA899	Green	04GAA902
Red	04GAA900	Blue	04GAA903
Yellow	04GAA901	Gray	04AAB208



### Inspection Certificate

- Every ratchet thimble micrometer is provided with a Certificate of Inspection that shows the result of the quality control inspection conducted at time of shipping.

- Coordinate Measuring Machines
- Vision Measuring Systems
- Form Measurement
- Optical Measuring
- Sensor Systems
- Testing Equipment and Seismometer
- Digital Scale and DRO Systems
- Small Tool Instruments and Data Management

### Dimensions

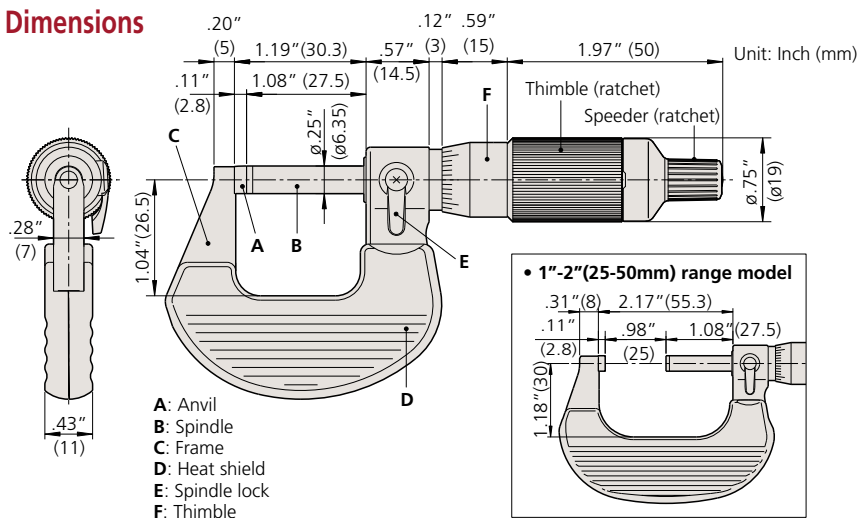

Note: All information regarding our products, and in particular the illustrations, drawings, dimensional and performance data contained in this pamphlet, as well as other technical data are to be regarded as approximate average values. We therefore reserve the right to make changes to the corresponding designs, dimensions and weights. The stated standards, similar technical regulations, descriptions and illustrations of the products were valid at the time of printing. In addition, the latest applicable version of our General Trading Conditions will apply. Only quotations submitted by ourselves may be regarded as definitive.

## Mitutoyo America Corporation

www.mitutoyo.com

### M<sup>3</sup> Solution Centers

**Aurora, Illinois**  
(Corporate Headquarters)  
(630) 978-5385

**Westford, Massachusetts**  
(978) 692-8765

**Huntersville, North Carolina**  
(704) 875-8332

**Mason, Ohio**  
(513) 754-0709

**Plymouth, Michigan**  
(734) 459-2810

**City of Industry, California**  
(626) 961-9661

**Kirkland, Washington**  
(408) 396-4428

# Mitutoyo

**Precision is our Profession**