

# Mitutoyo

Mitutoyo Quality

## SURFACE ROUGHNESS/CONTOUR MEASURING SYSTEM FORMTRACER SV-C3200/4500 SERIES

Dual-purpose measurement and powerful analysis of surface roughness and contour combined with high accuracy, high drive speed and simplified CNC measurement

FORM MEASUREMENT



Bulletin No. 2195(2)

# Hybrid measuring instrument for surface roughness and contour measurement

## Contour Measuring Functions

### Detector with new arm design

Mitutoyo's newly designed detector arm lowers workpiece interference while expanding the measurement range in the Z1 axis (detector).

- When using the SPH-71 one-sided cut stylus

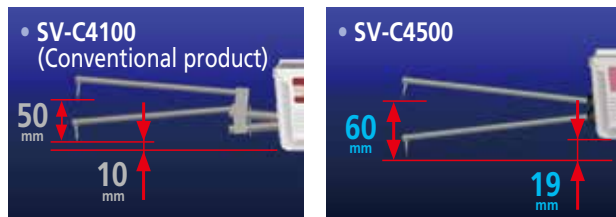

Detector measurement range expanded by 10 mm

### One-touch arm attachment (Patent pending in Japan)

The arm mount uses a magnetic joint for quick and easy arm replacement. The mount also includes a safety mechanism.

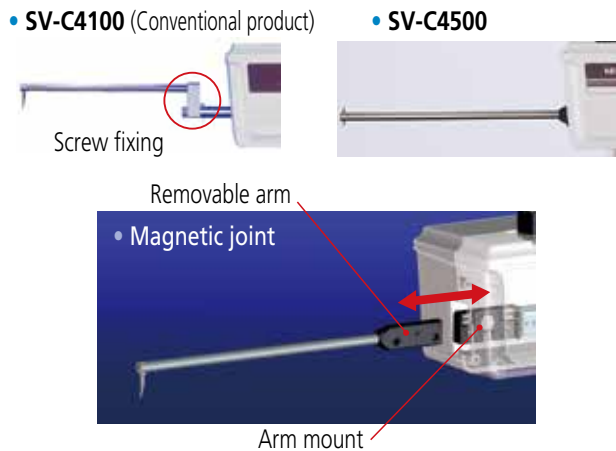

### New function specified for 4500 Series

#### Continuous top-bottom measurement function

Upper and lower surfaces can be measured continuously by using Mitutoyo's double-sided conical stylus.

This continuous measurement data can be used to facilitate analysis of features that were difficult to measure before, such as the effective diameter of an internal screw-thread.

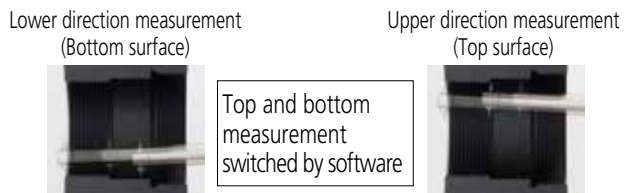

#### Continuous top-bottom measurement allows hassle-free one-step calibration

(Patent pending in Japan)

The one-step calibration kit supplied with the SV-C4500 Series has been upgraded to enable easy calibration of the double-ended conical stylus featuring a contact on both the top and the bottom. Precise work such as calibrating the Z1-axis gain, symmetry, and stylus radius can now be carried out in a single operation.

- Calibration kit for SV-C4500 Series

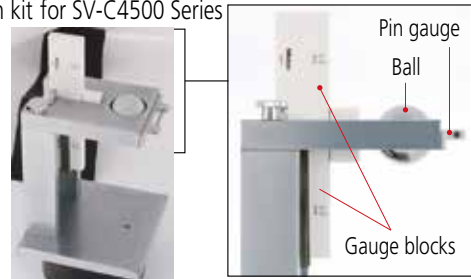

#### Variable measuring force function

The measuring force can be varied in 5 steps by using the software provided (**FORMTRACEPAK**), eliminating the need to adjust the measuring force by switching weights or through positional adjustment.

The SV-C4500 Series can also maintain the specified measuring force even when tilted.





SV-C4500S4



SV-C3200S4

## Surface Roughness Measuring Functions

### Supporting International Standards

Compliant with JIS '82/94/01, ISO, ANSI, DIN, VDA, and other international surface roughness standards.

### We offer a product lineup of surface roughness detectors with different measuring forces

Standard detectors can be selected (as listed below) to conform to the international standard required.

0.75mN (tip angle 60°; tip radius 2µm)

4mN (tip angle 90°; tip radius 5µm)

### Reduction of measuring time and operator's fatigue

In addition to high speed movement of main unit, reduction of setting time and operator's fatigue can be achieved by using Auto-leveling Table (option), which allows automatic leveling for a measuring face.

## Common specifications

### Fast traverse improves measurement efficiency

X axis (drive unit) : 80mm/s (MAX)

Z2 axis (column) : 30mm/s (MAX)

The total measurement time can be shortened by speeding up the traverse movements.

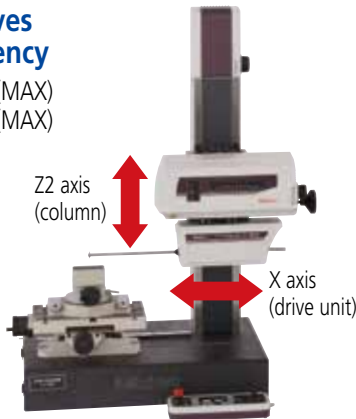

### Auto stop feature assures safety even during high-speed movement

The detector includes a safety mechanism (auto stop upon collision) to assure measurement safety even during high-speed movement. If the arm is removed or shifts during measurement, the safety mechanism is triggered and stops the machine.

Direction of collision that may cause the safety device to be triggered

- Detector for contour measuring

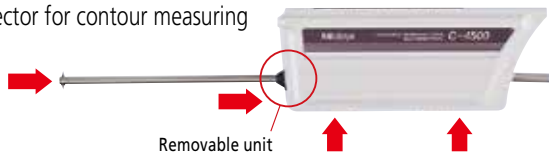

- Detector for surface roughness measuring



### Remote-control unit enables safe, easy & fast measurement

The remote-control unit lets you move quickly from positioning to measurement. The unit also features an emergency stop switch and speed control knob for added safety while the machine is moving at high speeds.



New Remote Control Box

Incorporation of an ABS scale in the Z2 axis eliminates the need for wearisome origin point re-setting conventionally required for every step of repeated measurements over stepped or multiple sections.

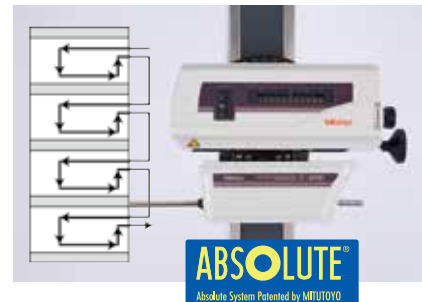

All detector and drive unit cables are housed inside the main unit to eliminate any risk of abrasion and guarantee trouble free, high-speed operation.



# Contour Analysis Software: FORMTRACEPAK

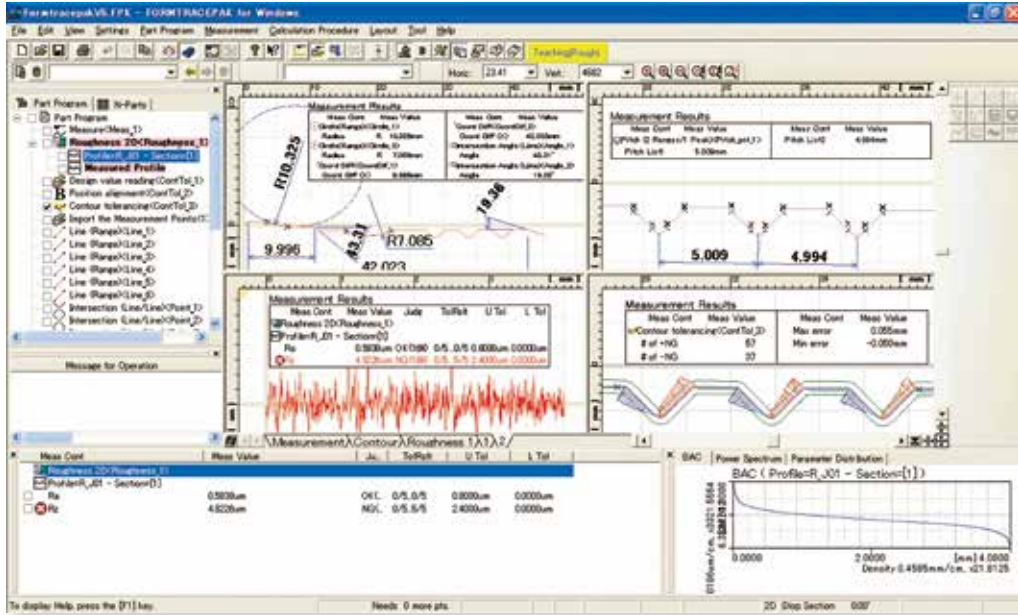

## Contour Measuring

- **Contour analysis function**

Upper and lower surfaces can be measured continuously by using Mitutoyo's double-sided conical stylus.

This continuous measurement data can be used to facilitate analysis of features that were difficult to measure before, such as the effective diameter of an internal screw-thread.

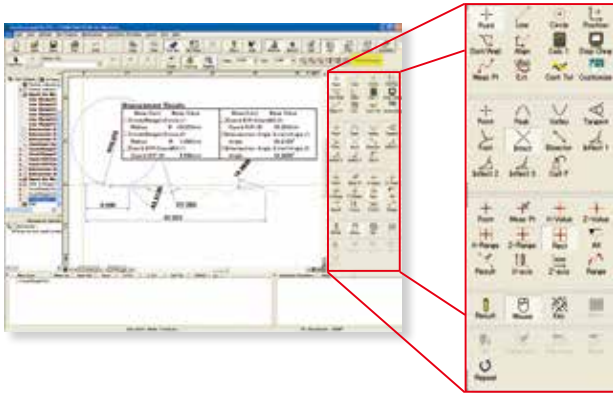

- Contour-tolerancing function as a standard feature
- Design value generation function
- Data combination function
- Simple pitch calculation function

## Surface Roughness Measuring

- **Surface Roughness analysis function**

FORMTRACEPAK can perform surface roughness analyses that conform to various standards such as ISO, JIS ANSI, and VDA. For comparing the measurement values with the tolerance limits, you can use the 16% rule or the maximum value rule. Furthermore, since FORMTRACEPAK comes with parameter calculation functions as well as a rich set of graphic analysis functions, it can be widely utilized for everything from routine quality control to R&D applications. It also includes many other functions, such as the function for eliminating (compensating) shapes, such as slopes and R-surface, and a data deletion function.

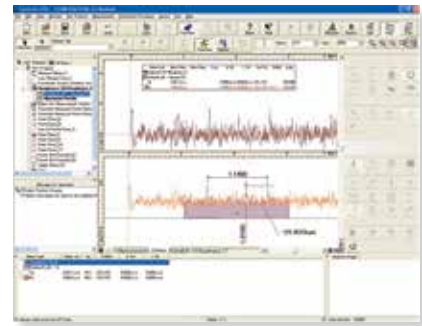

- Microscopic contour analysis function
- Simple input using drawing symbols
- Multiple-point measurement function
- Analysis function using multiple-point measurement
- Reference length dialog box
- Analysis condition modification with a preview function
- R-surface automatic measurement function

Note: Please refer to the FORMTRACEPAK catalog (2021) for more details.



# MiCAT

Mitutoyo Intelligent Computer Aided Technology

the standard in world metrology software

## FORM

### Integrated layout

You can use simple operations to lay out graphics obtained from measurements as well as measurement results for surface roughness, contour, and roundness on a single page. Furthermore, since the program now allows you to specify a saved file and paste it, you can easily paste results from multiple files.

Note: the optional ROUNDPAK roundness/cylindricity analysis program is required. (Ver. 7 or higher)

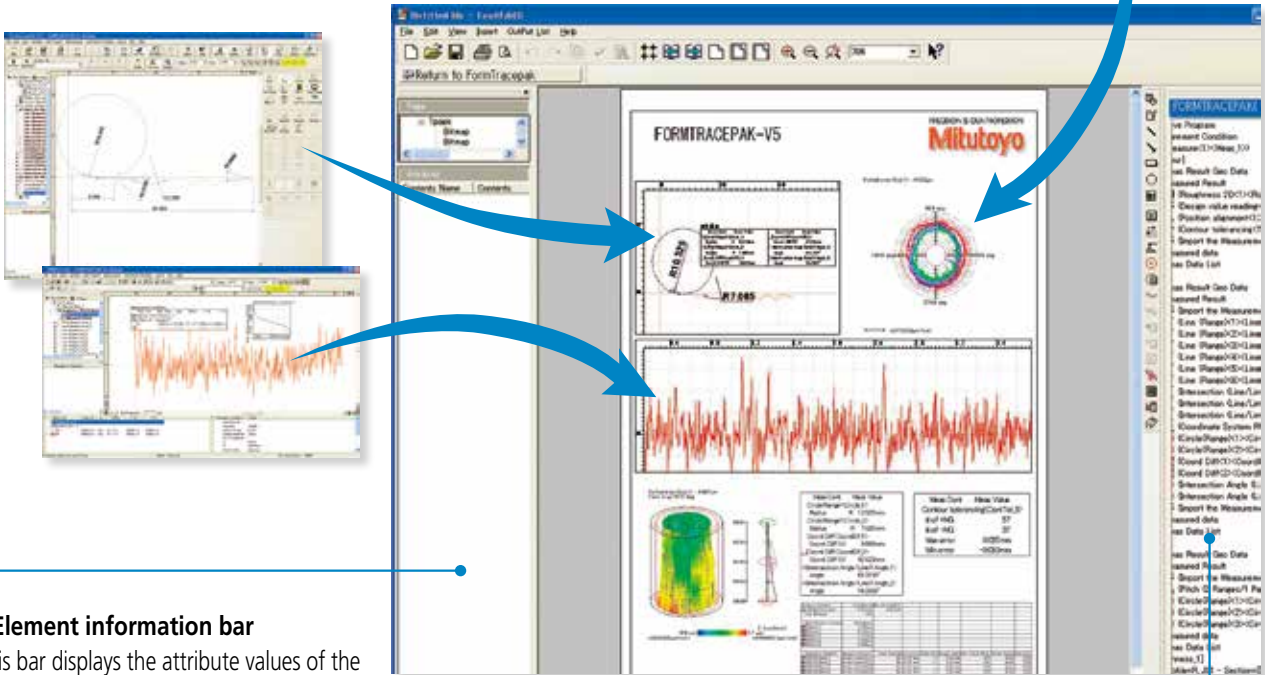
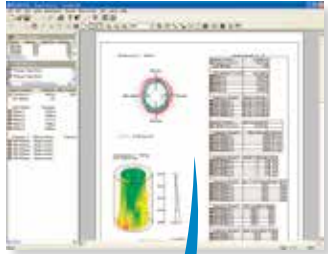

- **Element information bar**

This bar displays the attribute values of the pasted items, allowing you to easily check the contents of the pasted measurement data files.

- **System layout printing**

By simply selecting the items to be output, you can automatically lay out the page to be printed. Use this feature when you wish to simplify the printing task.

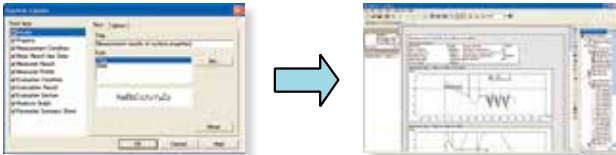

- **Report creation function**

You can freely assemble measurement results/conditions/graphics as well as comments/circles/lines/arrows, and print them out in a measurement result report. Furthermore, since you can paste bitmap files, you can also add a workpiece image or company logo to the layout. You can also save the created layout and use it again later for similar measurements.

- **Element insertion bar**

Using the mouse to drag and drop the analysis content displayed in the element insertion bar, you can paste it onto the layout. From the contour analysis result, you can also select the analysis result for a circle or line alone and paste it in position.

- **Saving the result as a web page**

Since you can save the result in html or mhtml format, which can be displayed using Internet Explorer or Microsoft Word, you can check the result even on a PC in which no layout-editing program is installed.

# Optional Accessories for Automatic Measurement

## Y-axis table: 178-097 / 178-096

A Y-axis table for positioning and capable of 3D surface roughness measurement when used with FORMTRACEPAK-Pro or MCubeMap.



178-097

	178-097	178-096
Travel range	200mm	100mm
Resolution	0.05μm	0.05μm
Positioning accuracy	±3μm	-
Straightness accuracy	-	0.3μm/100mm
Drive speed	Max. 80mm/s	0-20mm/s
Maximum load	50kg	15kg
Mass	28kg	31kg



178-096

\*Not supporting Y-axis measurements

## Rotary Table $\theta$ 1-axis table: 12AAD975\*

For efficient measurement in the axial/transverse directions. When measuring a cylindrical workpiece, automatic alignment can be performed in combination with the Y-axis table.

\* $\theta$ 1-axis mounting plate (12AAE630) is required when directly installing on the base of the SV-C3200/4500.

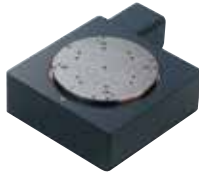

Displacement	360°
Resolution	0.004°
Maximum load	12kg
Rotational speed	Max. 10°/s
Mass	7kg



## Rotary Table $\theta$ 2-axis unit: 178-078\*

You can measure multiple points on a cylindrical workpiece and automate front/rear-side measurement.

\* $\theta$ 2-axis mounting plate (12AAE718) is required when directly installing on the base of the SV-C3200/4500.



Displacement	360°
Resolution	0.0072°
Maximum load (loading moment)	4kg (343 N·cm or less)
Rotational speed	Max. 18°/s
Mass	5kg



## Centering chuck (ring operated): 211-032

This chuck is useful when measuring small workpieces. You can easily clamp them with its knurled ring.



Clamping range	Jaws normal	OD: $\phi$ 1 - $\phi$ 36mm
	Jaws normal	ID: $\phi$ 16 - $\phi$ 69mm
	Jaws reversed	OD: $\phi$ 25 - $\phi$ 79mm
Dimensions	$\phi$ 118x41mm	
Mass	1.2kg	

## Micro-chuck: 211-031

This chuck is suitable for clamping extra-small diameter workpieces ( $\phi$ 1 mm or less), which cannot be retained with the centering chuck.



Clamping range	OD: $\phi$ 0.1 - $\phi$ 1.5mm
Dimensions	$\phi$ 118x48.5mm
Mass	0.6kg

## Auto-leveling table: 178-087 / 178-077

This is a stage that performs fully automatic leveling as measurement starts, freeing the user from this troublesome operation. Fully automatic leveling can be done quickly by anyone. In addition, the operation is easy and reliable.



178-087

	178-087	178-077
Inclination adjustment angle	±2°	±2°
Maximum load	7kg	-
Maximum load (on Y-axis table)	-	10kg
Maximum load (on Y-axis table + Theta-1-axis table)	-	6kg
Table dimensions	130x100mm	139x139mm
Mass	3.5kg	4.5kg
Mass	28kg	31kg



178-077

\*Used with 178-096 for 3D surface roughness measurements

# Options

## 3-axis Adjustment Table: 178-047

This table helps make the alignment adjustments required when measuring cylindrical surfaces. The corrections for the pitch angle and the swivel angle are determined from a preliminary measurement and the Digimatic micrometers are adjusted accordingly. A flat-surfaced work-piece can also be leveled with this table.



\* V-block not included

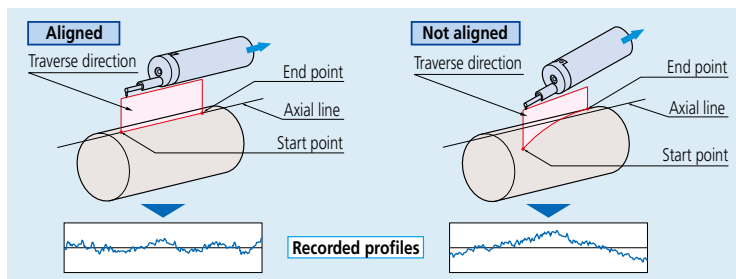

## Table and fixture systems

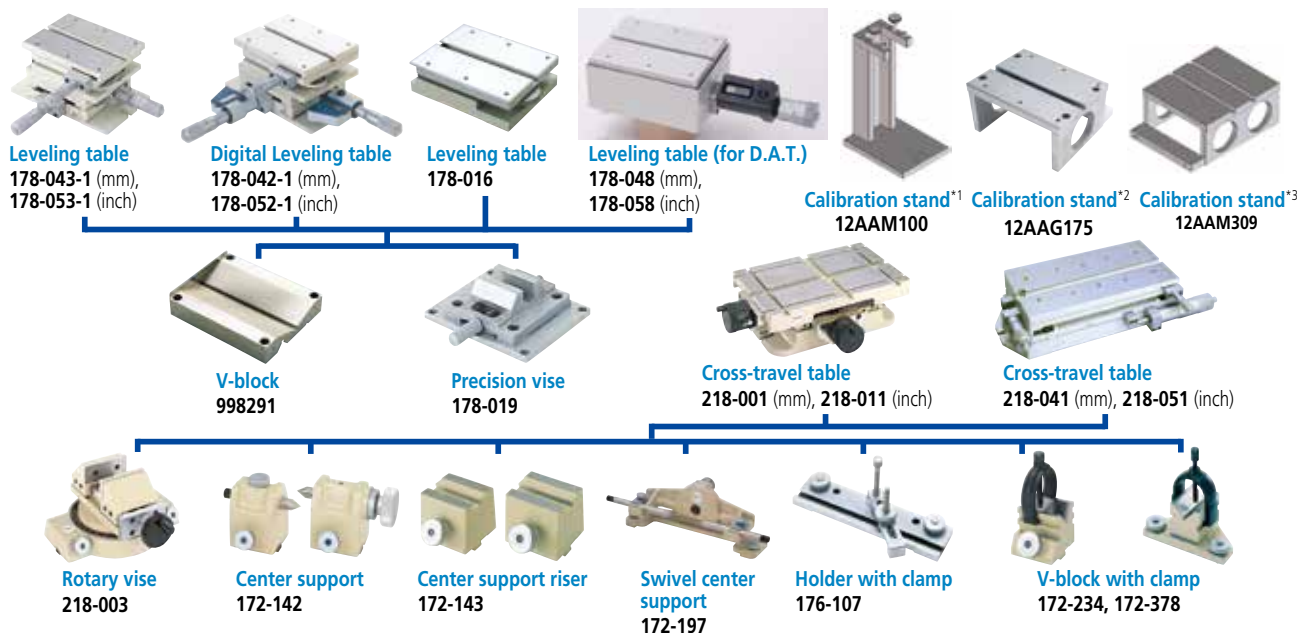

### • Desk type vibration isolators

Manually charged pneumatic type<sup>\*4</sup>



Automatically charged pneumatic type<sup>\*4</sup>  
No.178-025

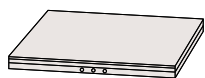

Stand for Desktop type  
External size (WxDxH):640x470x660mm  
Mass: 25kg

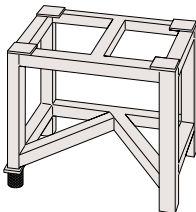

### • Desk type vibration isolators

Desk type<sup>\*4</sup>  
No.12AAK110

Monitor arm<sup>\*5</sup>  
No.12AAK120

Side table<sup>\*5</sup>  
No.12AAL019



Example combination: with side table but no monitor arm (tester and PC not included)

Example combination: with monitor arm but no side table<sup>\*6</sup> (tester and PC not included)

\*1 Required for calibrating upward measurement of SV-C3200 series.

\*2 Required for calibrating in bulk by mounting straight arm/small-hole stylus arm without using cross-travel table and Y-axis table.

\*3 Required for calibrating in bulk by mounting straight arm/eccentric arm/small-hole stylus arm without using cross-travel table and Y-axis table.

\*4 For models with a product code that ends in S4, S8, H4, or H8. Please contact us directly if you require units for models with a product code that ends in W4/L4 or W8/L8 (large base models).

\*5 Used together with vibration isolator (No.12AAK110).

\*6 User to provide a printer rack.







178-074



178-091



178-092

## Styli

### For deep groove (10mm)

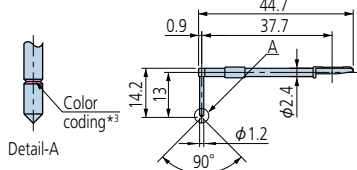

12AAC735 (2μm) \*1  
12AAB409 (5μm)  
12AAB421 (10μm)  
( ): Tip radius

### For deep groove \*2 (20mm)

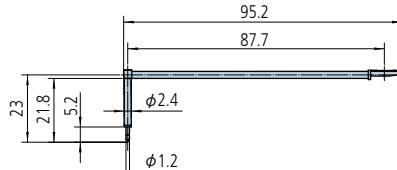

12AAE893 (2μm) \*1  
12AAE909 (5μm)  
( ): Tip radius

### For deep groove \*2 (20mm)

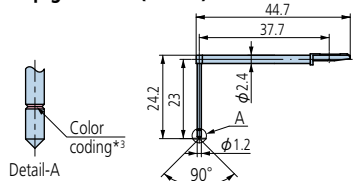

12AAC736 (2μm) \*1  
12AAB408 (5μm)  
12AAB420 (10μm)  
( ): Tip radius

### For deep groove \*2 (40mm)

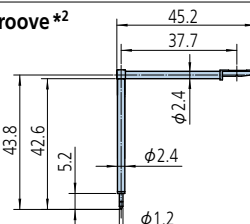

12AAE895 (2μm) \*1  
12AAE911 (5μm)  
( ): Tip radius

### For deep groove \*2 (30mm)

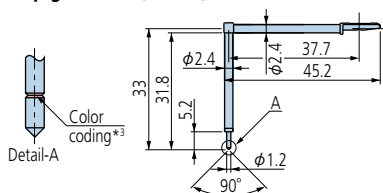

12AAC737 (2μm) \*1  
12AAB407 (5μm)  
12AAB419 (10μm)  
( ): Tip radius

### For deep groove (30mm)/Double-length for deep hole \*2

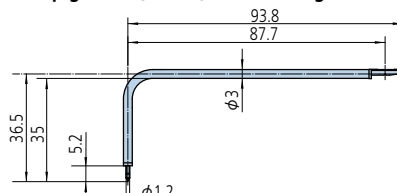

12AAE894 (2μm) \*1  
12AAE910 (5μm)  
( ): Tip radius

### For gear tooth

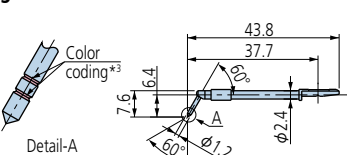

12AAB339 (2μm) \*1  
12AAB410 (5μm)  
12AAB422 (10μm)  
( ): Tip radius

### For gear tooth/Double-length for deep hole \*2

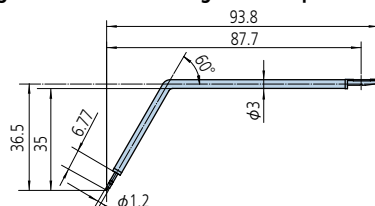

12AAE896 (2μm) \*1  
12AAE912 (5μm) \*1  
( ): Tip radius

### For rolling circle waviness surface \*4

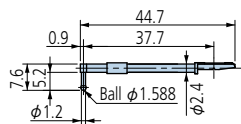

12AAB338 (φ1.588)  
( ): Tip radius

### For rolling circle waviness/Double-length for deep hole \*2 \*4

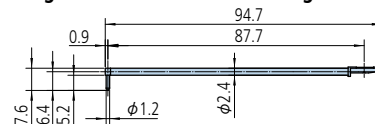

12AAE886 (250μm)  
( ): Tip radius

### For knife-edge \*4

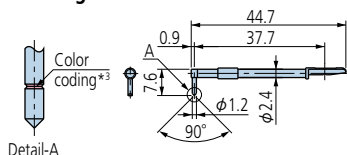

12AAC738 (2μm) \*1  
12AAB411 (5μm)  
12AAB423 (10μm)  
( ): Tip radius

### For corner hole/Double-length for deep hole \*2

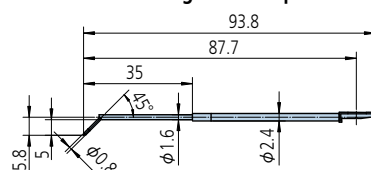

12AAE897 (2μm) \*1  
12AAE913 (5μm) \*2  
( ): Tip radius

### For eccentric arm \*2

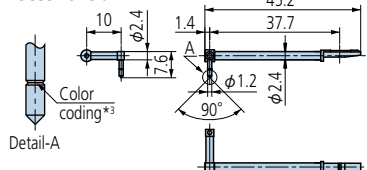

12AAC739 (2μm) \*1  
12AAB412 (5μm)  
12AAB424 (10μm)  
( ): Tip radius

### For bottom surface

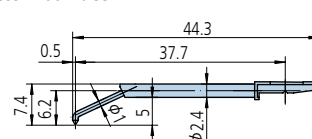

12AAE899 (2μm) \*1  
12AAE915 (5μm)  
( ): Tip radius

\*1: Tip angle 60°

\*2: For downward-facing measurement only.

Customized special interchangeable styli are available on request. Please contact any Mitutoyo office for more information.

\*3:

Tip radius	2μm	5μm	10μm
Color coding	Black	No color	Yellow

\*4: Used for calibration, a standard step gauge (No.178-611 (mm), No.178-612 (mm), option) is also required

# Arms / Styli (For Contour Measuring)

## Arms

Description	Arm No.	Parts No.	Applicable stylus No.
Straight arm	AB-31*1	12AAM101	SPH-5*, 6*, 7*, 8*, 9*, SPHW*2-56,66,76
Eccentric arm	AB-37	12AAQ762	SPH-5*, 6*, 7*, 8*, 9*, SPHW*2-56,66,76
Small-hole arm	AB-33	12AAM103	SPH-41, 42, 43

\*1 Standard accessory

\*2 Stylus for SV-C4500 series

\*3 One-sided cut stylus SPH-71 (standard accessory) mounting

• Straight arm **AB-31**

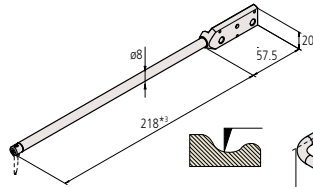

• Eccentric arm **AB-37**

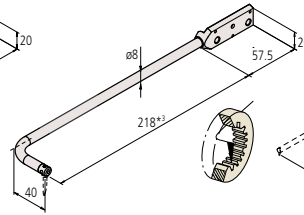

• Small-hole arm **AB-33**

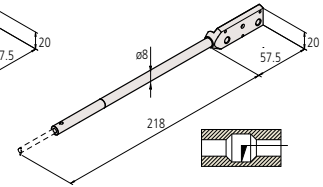

## Styli

Stylus name	Stylus No.	Parts No.	Application arm No.	H (mm)
Double-sided conical stylus*1	SPHW-56	12AAM095*2	AB-31, AB-37	20
	SPHW-66	12AAM096	AB-31, AB-37	32
	SPHW-76	12AAM097	AB-31, AB-37	48
One-sided cut stylus	SPH-51	354882	AB-31, AB-37	6
	SPH-61	354883	AB-31, AB-37	12
	SPH-71	354884*2*3	AB-31, AB-37	20
	SPH-81	354885	AB-31, AB-37	30
	SPH-91	354886	AB-31, AB-37	42
Intersecting cut stylus	SPH-52	354887	AB-31, AB-37	6
	SPH-62	354888	AB-31, AB-37	12
	SPH-72	354889	AB-31, AB-37	20
	SPH-82	354890	AB-31, AB-37	30
Cone stylus Tip angle 30° Sapphire tipped	SPH-92	354891	AB-31, AB-37	42
	SPH-53	354892	AB-31, AB-37	6
	SPH-63	354893	AB-31, AB-37	12
	SPH-73	354894	AB-31, AB-37	20
	SPH-83	354895	AB-31, AB-37	30
Cone stylus Tip angle 30° Carbide-tipped	SPH-93	354896	AB-31, AB-37	42
	SPH-56	12AAA566	AB-31, AB-37	6
	SPH-66	12AAA567	AB-31, AB-37	12
	SPH-76	12AAA568	AB-31, AB-37	20
Cone stylus Tip angle 20° Carbide-tipped	SPH-86	12AAA569	AB-31, AB-37	30
	SPH-96	12AAA570	AB-31, AB-37	42
	SPH-57	12AAE865	AB-31, AB-37	6
	SPH-67	12AAE866	AB-31, AB-37	12
Cone stylus Tip angle 20° Carbide-tipped	SPH-77	12AAE867	AB-31, AB-37	20
	SPH-87	12AAE868	AB-31, AB-37	30
	SPH-97	12AAE869	AB-31, AB-37	42
Cone stylus Tip angle 50° Diamond tipped	SPH-79	355129	AB-31, AB-37	20
	SPH-54	354897	AB-31, AB-37	6
Knife edge stylus	SPH-64	354898	AB-31, AB-37	12
	SPH-74	354899	AB-31, AB-37	20
	SPH-84	354900	AB-31, AB-37	30
	SPH-94	354901	AB-31, AB-37	42
	SPH-55	354902	AB-31, AB-37	6
Ball stylus	SPH-65	354903	AB-31, AB-37	12
	SPH-75	354904	AB-31, AB-37	20
	SPH-85	354905	AB-31, AB-37	30
Small hole stylus*4	SPH-95	354906	AB-31, AB-37	42
	SPH-41	12AAM104	AB-33	2
	SPH-42	12AAM105	AB-33	4
SPH-43	12AAM106	AB-33	6.5	

\*1 Stylus for SV-C4500 series

\*2 Standard accessory of SV-C4500 series

\*3 Standard accessory of SV-C3200 series

\*4 Styli SPH-21, 22, and 23 for SV-C3100/4100 series are not available.

Double-sided conical stylus

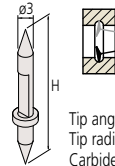

Tip angle: 30°  
Tip radius: 25µm  
Carbide-tipped

Cone stylus

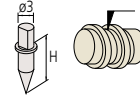

Tip angle: 30° (SPH-79: 50°)  
Tip radius: 25µm  
Sapphire, Carbide-tipped  
(SPH-79: Diamond tipped)

Small hole stylus SPH-41

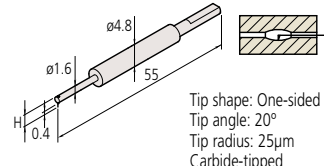

Tip shape: One-sided cut  
Tip angle: 20°  
Tip radius: 25µm  
Carbide-tipped

One-sided cut stylus

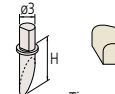

Tip angle: 12°  
Tip radius: 25µm  
Carbide-tipped

Cone stylus

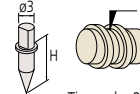

Tip angle: 20°  
Tip radius: 25µm  
Carbide-tipped

Small hole stylus SPH-42

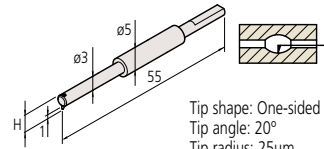

Tip shape: One-sided cut  
Tip angle: 20°  
Tip radius: 25µm  
Carbide-tipped

Intersecting cut stylus

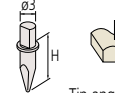

Tip angle: 20°  
Tip radius: 25µm  
Carbide-tipped

Knife edge stylus

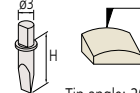

Tip angle: 20°  
Edge width: 3mm  
Tip radius: 25µm  
Carbide-tipped

Small hole stylus SPH-43

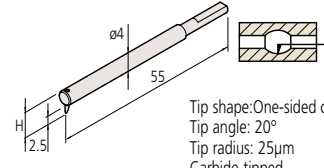

Tip shape: One-sided cut  
Tip angle: 20°  
Tip radius: 25µm  
Carbide-tipped

Ball stylus

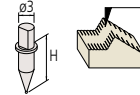

Ball dia: 1mm  
Carbide-tipped

## Arm stylus (integrated arm and stylus) only for CV-4500

Arm stylus name	Order No.	H (mm)	Tip angle
Double small-hole arm stylus*8	12AAT469	2.4	20°
	12AAT470	5	20°
	12AAM108	2.4	30°
	12AAM109	5	30°
	12AAM110	9	30°

\*8: Arm Stylus for CV-4500, SV-C4500 and SV-C4500CNC series, series

• Double small-hole arm stylus: **12AAM108/12AAT469**

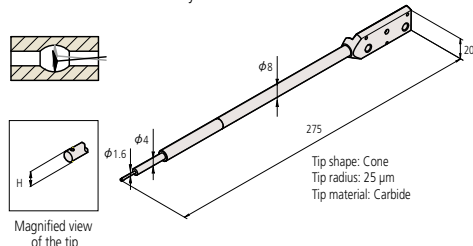

• Double small-hole arm stylus: **12AAM109/12AAT470**

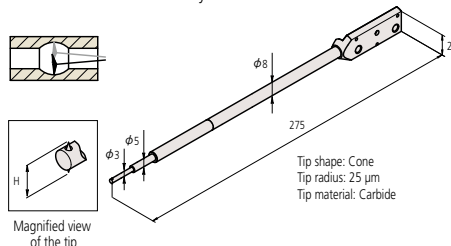

• Double small-hole arm stylus: **12AAM110**

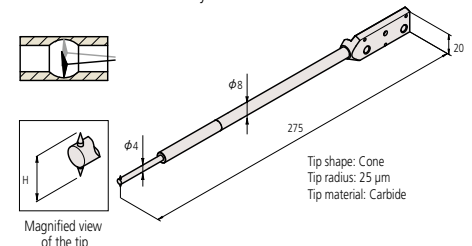

# Dimensions

## X-axis (drive unit) measuring range : 100mm TYPE (S4/H4/W4/L4)

Unit: mm

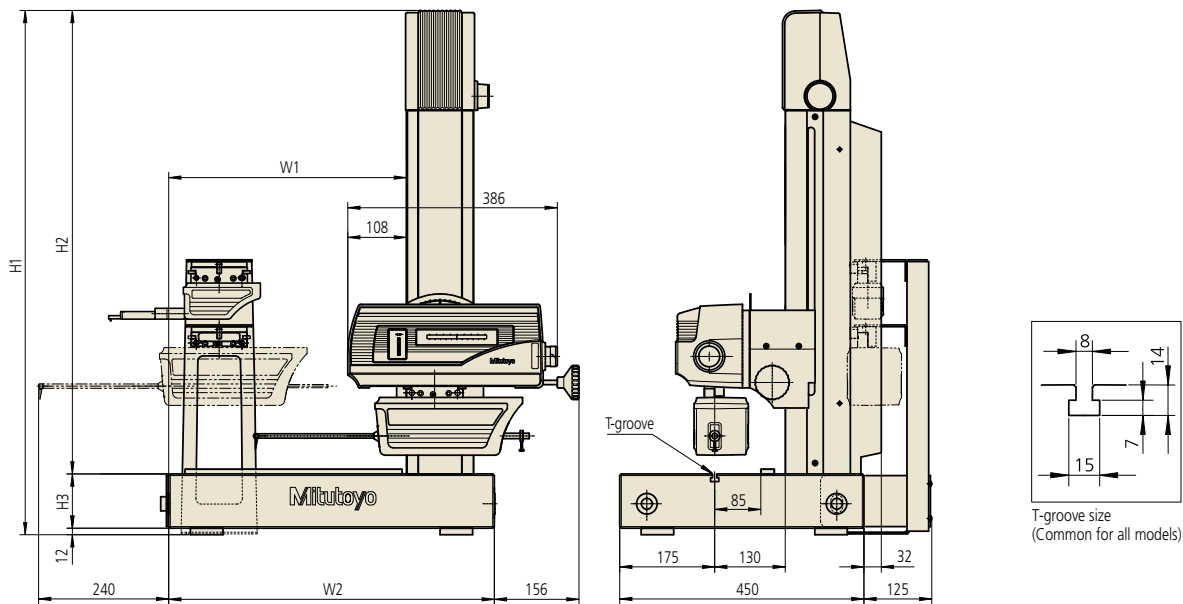

## X-axis (drive unit) measuring range : 200mm TYPE (S8/H8/W8/L8)

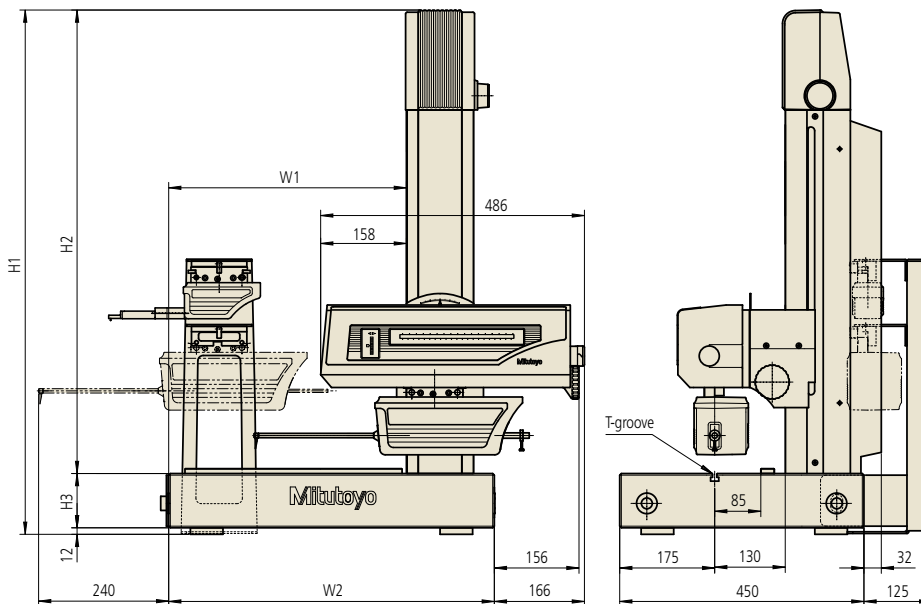

X-axis (drive unit) Measuring range	Models		H1 (mm)	H2 (mm)	H3 (mm)	W1 (mm)	W2 (mm)
	3200 Series	4500 Series					
100mm	SV-C3200S4	SV-C4500S4	966	854	100	438	600
	SV-C3200H4	SV-C4500H4	1166	1054	100	438	600
	SV-C3200W4	SV-C4500W4	1176	1054	110	838	1000
	SV-C3200L4	SV-C4500L4	1426	1304	110	825	1000
200mm	SV-C3200S8	SV-C4500S8	966	854	100	438	600
	SV-C3200H8	SV-C4500H8	1166	1054	100	438	600
	SV-C3200W8	SV-C4500W8	1176	1054	110	838	1000
	SV-C3200L8	SV-C4500L8	1426	1304	110	825	1000

# Specifications

Model No. (Order No.)	SV-C3200S4 (525-491-11A)	SV-C3200H4 (525-492-11A)	SV-C3200W4 (525-493-11A)	SV-C3200L4 (525-494-11A)	SV-C3200S8 (525-496-11A)	SV-C3200H8 (525-497-11A)	SV-C3200W8 (525-498-11A)	SV-C3200L8 (525-498-11A)
	SV-C4500S4 (525-451-11A)	SV-C4500H4 (525-452-11A)	SV-C4500W4 (525-453-11A)	SV-C4500L4 (525-454-11A)	SV-C4500S8 (525-456-11A)	SV-C4500H8 (525-457-11A)	SV-C4500W8 (525-458-11A)	SV-C4500L8 (525-458-11A)

## Specifications for Surface Roughness Measurement

Measuring range	X axis (drive unit)	100mm	200mm
	Z1 axis (detector unit)	80μm / 80μm / 8μm	
Straightness		(0.05+0.001L) μm L = Drive length (mm)	(0.1+0.002L) μm (4+2L) μin
Resolution	Z1 axis (detector unit)	0.01μm (800μm) , 0.001μm (80μm) , 0.0001μm (8μm)	
Measuring force		0.75mN or 4mN	
Stylus tip		60°, 2μmR (Measuring force: 0.75mN) or 90°, 5μmR (Measuring force: 4mN)	
Conformable standards		JIS1982/JIS1994/JIS2001/ISO1997/ANSI/VDA	
Parameters		Pa, Pq, Psk, Pku, Pp, Pv, Pz, Pt, Pc, PSm, PAq, Pm (rC) Pmr, Ppc, Ra, Rq, Rsk, Rku, Rp, Rv, Rz, Rt, Rc, RSm, RΔq, Rm (rC) Rmr, Rc, Wa, Wq, Wsk, Wku, Wp, Wv, Wz, Wt, Wc, WSm, WAq, Wm (rC) Wmr, Wpc, Rk, Rpk, Rvk, Mr1, Mr2, A1, A2, Rx, AR, R, Wx, AW, W, Wte, Ry, RyDIN, RzDIN, R3y, R3z, S, HSC, Lo, Ir, Δa, λa, λq, Vo, Htp, NR, NCRX, CPM, SR, SAR, NW, SW, SAW	
Assessed profiles		Primary Profile, Roughness profile, Envelope residual curve, Filtered waviness curve, Band pass waviness curve, Waviness curve, Rolling circle waviness curve, Roughness motif, Waviness motif, DIN4776 curve	
Graphs		Amplitude distribution graphs, BAC1, BAC2, Power spectrum curve, Auto correlation curve Inclination angle distribution curve, Peak point height distribution curve, Parameter distribution curve	
Data compensation		Tilt compensation, R-surface compensation, Ellipse Compensation, Parabola compensation, Hyperbolic compensation, Polynomial compensation, Conic automatic compensation, Polynomial automatic compensation	
Filters		Gaussian filter, 2CRPC75, 2CRPC50, 2CR75, 2CR50, Robust spline filter	

## Specifications for Contour Measurement

Measuring range	X axis (drive unit)	100mm	200mm
	Z1 axis (detector unit)	60mm (±30mm in horizontal situation)	
Straightness (when the X axis is horizontal)		0.8μm / 100mm	2μm / 200mm
Accuracy	X axis (drive unit)	± (0.8+0.01L) μm L = Drive length (mm)	± (0.8+0.02L) μm L = Drive length (mm)
	Z1 axis (detector unit)	SV-C3200 series: ± (1.6+2H /100) μm, SV-C4500 series: ± (0.8+2H /100) μm H = Measurement height from the horizontal position (mm)	
Resolution	X axis (drive unit)	0.05μm	
	Z1 axis (detector unit)	SV-C3200 series: 0.04μm, SV-C4500 series: 0.02μm	
	Z2 axis (column)	1μm	
Measuring force		SV-C3200 series: 30mN, SV-C4500 series: 10, 20, 30, 40, 50mN (Setting measuring force FORMTRACEPAK)	
Measuring face direction		SV-C3200 series: Both upward and downward, SV-C4500 series: Both upward and downward (direction switch from FORMTRACEPAK)	

## Common Specifications

Z2-axis (column) travel range	300mm	500mm	700mm	300mm	500mm	700mm
X-axis inclination angle	±45°					
Drive speed	X axis	0~80mm/s and manual operation				
	Z2 axis (column)	0~30mm/s and manual operation				
Measuring speed	0.02~5mm/s					



Mitutoyo America Corporation  
www.mitutoyo.com  
One Number to Serve You Better  
1-888-MITUTOYO (1-888-648-8869)

### M<sup>3</sup> Solution Centers:

Aurora, Illinois (Headquarters)  
Boston, Massachusetts  
Huntersville, North Carolina  
Mason, Ohio  
Plymouth, Michigan  
City of Industry, California  
Birmingham, Alabama  
Renton, Washington  
Houston, Texas



Find additional product literature and our product catalog

www.mitutoyo.com

**Note:** All information regarding our products, and in particular the illustrations, drawings, dimensional and performance data contained in this printed matter as well as other technical data are to be regarded as approximate average values. We therefore reserve the right to make changes to the corresponding designs. The stated standards, similar technical regulations, descriptions and illustrations of the products were valid at the time of printing. In addition, the latest applicable version of our General Trading Conditions will apply. Only quotations submitted by ourselves may be regarded as definitive. Specifications are subject to change without notice.

Mitutoyo products are subject to US Export Administration Regulations (EAR). Re-export or relocation of our products may require prior approval by an appropriate governing authority.

### Trademarks and Registrations

Designations used by companies to distinguish their products are often claimed as trademarks. In all instances where Mitutoyo America Corporation is aware of a claim, the product names appear in initial capital or all capital letters. The appropriate companies should be contacted for more complete trademark and registration information.

Coordinate Measuring Machines

Vision Measuring Systems

Form Measurement

Optical Measuring

Sensor Systems

Test Equipment and Seismometers

Digital Scale and DRO Systems

Small Tool Instruments and Data Management

1.5M 0716-01 • Printed in USA • July 2016

© 2016 Mitutoyo America Corporation